

Note:

1. All of the Pin 1 of Connectors Match the Red Stripe.

REVISIONS			
REV	DESCRIPTION	DATE	APPROVED
A		07/07/98	

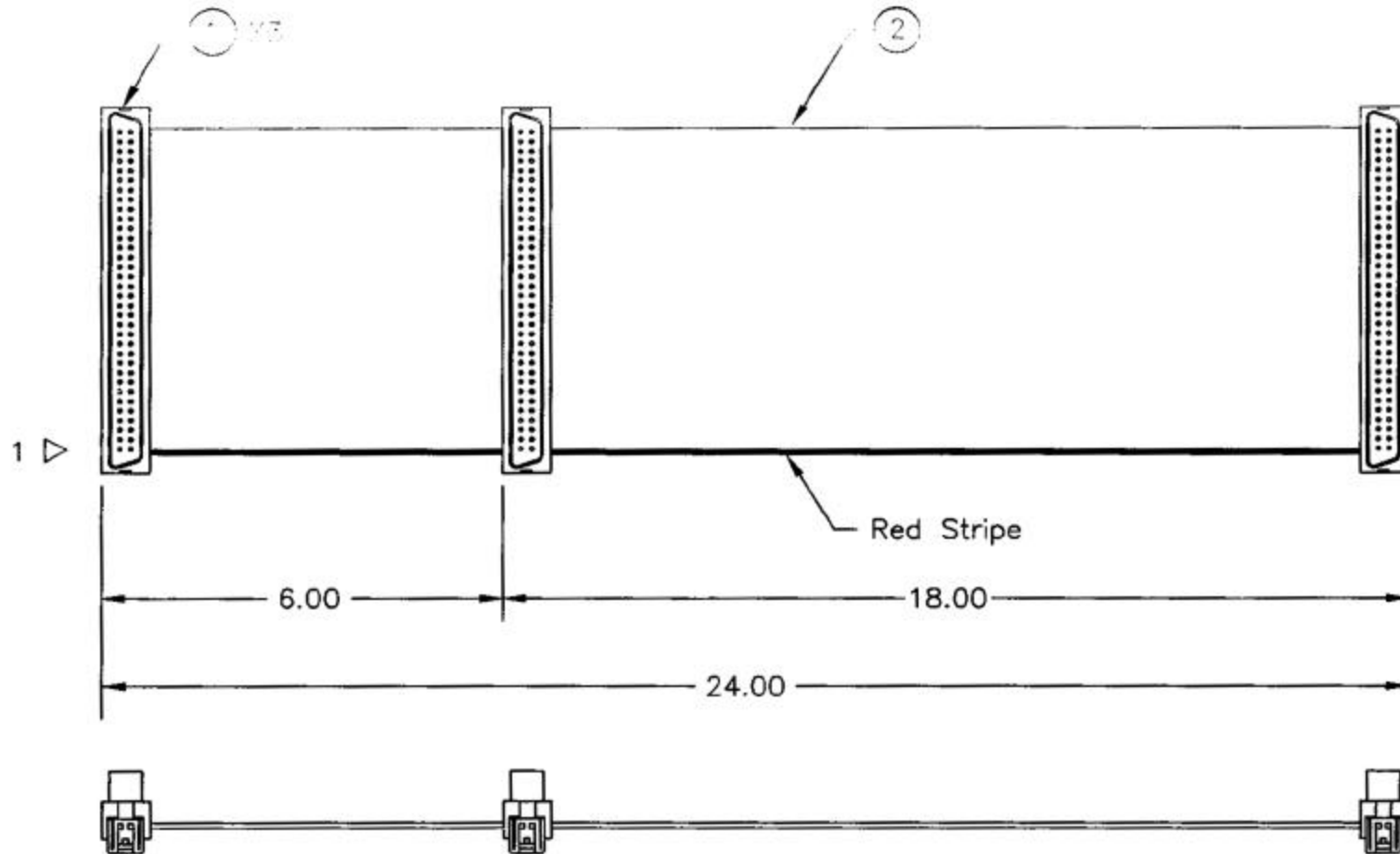

2	68 Cond., 30 AWG Stranded Flat Ribbon Cable		
1	68 Pin Male Connector		
UNLESS OTHERWISE SPECIFIED TOLERANCE: .XX ± 0.25		68P Male Conn. X3, 24"	
CUSTOMER P/N D11-SD68M-2		TNT Tri-Net Technology / U.S.A.	
DRAWN BY JONG	SIZE A	DWG NO. RIB-10704	REV A
UNIT INCH	SCALE NONE	http://www.trinetusa.com	SHEET 1 of 1