

REVISIONS				
ZONE	REV	DESCRIPTION	DATE	APPROVED
	1			
	1			

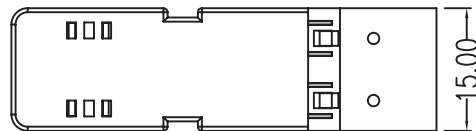
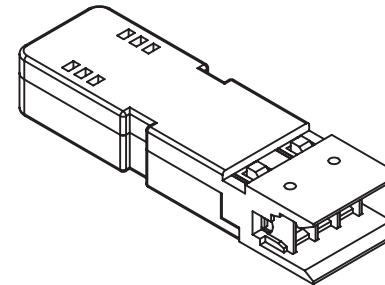
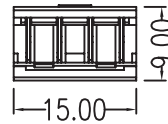
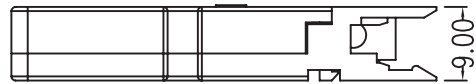
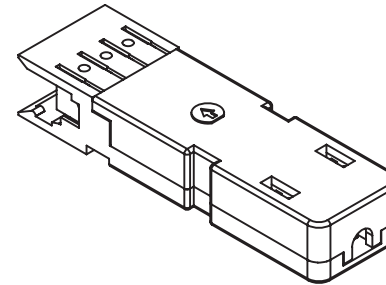
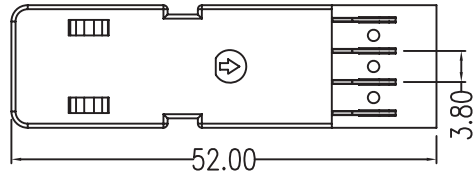

MATERIALS

PLASTIC: PC UL94V-0

Phosphor Bronze C5191R-H,

t=0.4mm, 2u" Gold over 40u" Nickel undercoat

TEMPERATURE: -40 ° C ~ 68° C

HUMIDITY: 10 % ~ 90% RH



COMMON TOLERANCE			SHEET OF		ALL COPY RIGHTS RESERVED	
CLASS DIMENSION	A	B	SIZE	A4	 Tri-Net Technology, Inc. TITLE <h1>094-2</h1>	
	L<=3	±0.05	±0.1	DIA		
3<L<=6	±0.05	±0.1	SCALE	1:1		
6<L<=16	±0.1	±0.15	DATE	2004.02.04	DRAWING NO.	
16<L<=30	±0.1	±0.2	DESIGN		DRAWN	CHECKED
30<L<=120	±0.15	±0.3				
120<L<=315	±0.2	±0.5				