

CUSTOMER: TNTUSA

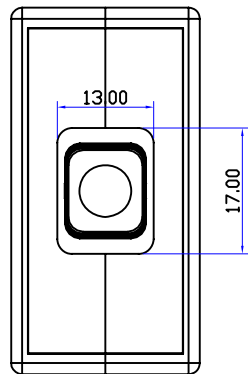

The back of product

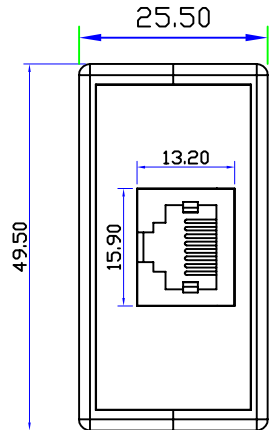
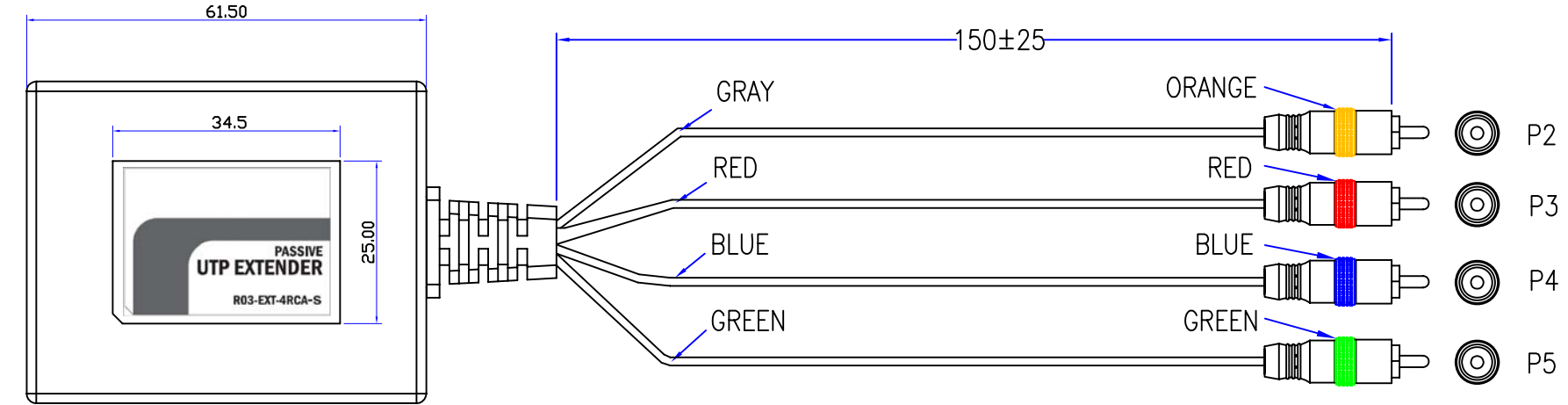
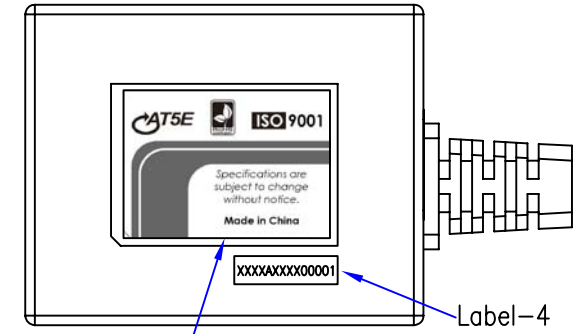

Features:

- No software or power adapter required for easy installation.
- Support up HDTV (.480p/720p/1080i)
- Works with UTP (Cat5/5e/6) cable.
- Shell color: Black

Applications

- To be used in home or commercial applications as a fast, and cost-effective means of connecting composite video equipment.
- Ideal for classrooms, projectors, convention facilities, and retail displays.

Label-2 (BLACK ON GREY)

Description:

The perfect solution for connecting component video devices using UTP(Cat5/5e/6) cable, this Component Video (YPbPr) UTP Extender lets you extend signals up to 300ft./100m. With no software or power adapter required, installation and setup is quick and hassle-free.

A	INITIAL RELEASE		02/25/10	
REV	DESCRIPTION OF CHANGE		DATE	
TOLERANCE		M/M		Tri-Net Technology, Inc. <a href="http://www.trinetusa.com">http://www.trinetusa.com</a>
INCHES				
.X	.015	.30		
.XX	.010	.10	SCALE NONE	REV A
.XXX	.005	.05	UNIT MM	
DRAWN BY	start		SHEET 1/3	DWG NO.
CHECK BY			DATE 02/25/10	
APPD BY			TITLE	
			COMPONENT VIDEO+DIGITAL AUDIO(4RCA),ONE PIECE	
			PART NO.	R03-EXT-4RCA-S



CUSTOMER: TNTUSA

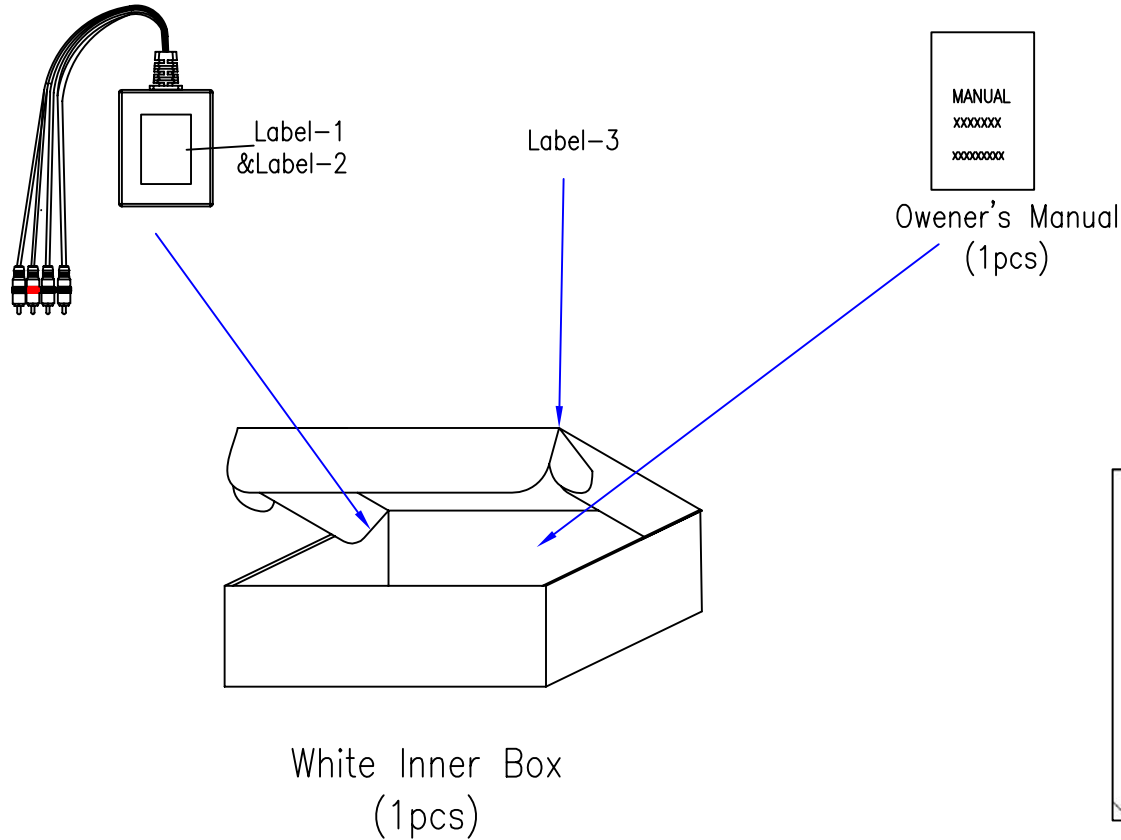

Label-1(34.5\*25mm)  
(BLACK ON GREY)

Packaging Details:

- 1) Stick the label-1 onto the Product's TOP.  
Label-2, Label-4 onto the Product's Bottom.
- 2) Need to put owner's manual inside the inner box
- 3) Stick the Label-3 onto this inner box.
- 4) Inner box size: 125(L)X75(W)X29(H)MM
- 5) Outer carton size: 405(L)X370(W)X185(H)MM
- 6) Put 60pcs of inner boxes into an outer carton.

A	INITIAL RELEASE		02/25/10	
REV	DESCRIPTION OF CHANGE		DATE	
TOLERANCE		M/M		Tri-Net Technology, Inc. <a href="http://www.trinetusa.com">http://www.trinetusa.com</a>
INCHES				
.X	.015	.30		
.XX	.010	.10		SCALE NONE
.XXX	.005	.05		UNIT MM
DRAWN BY		start		REV A
CHECK BY		DATE 02/25/10		
APPD BY		TITLE		DWG NO.
		COMPONENT VIDEO+DIGITAL AUDIO(4RCA)		
		PART NO.		R03-EXT-4RCA



CUSTOMER: TNTUSA

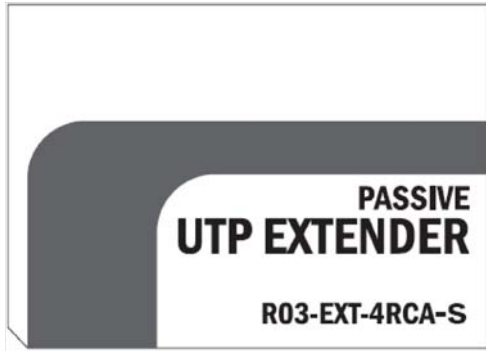

Label-2(34.5\*25mm)  
(BLACK ON GREY)

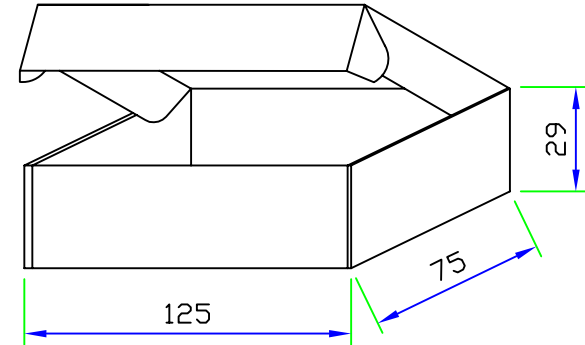

White Inner Box

Version Label (Label-4)

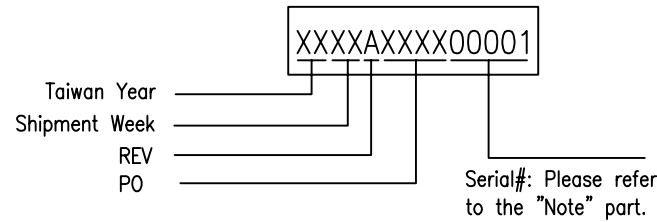

(18x6, Black on White)

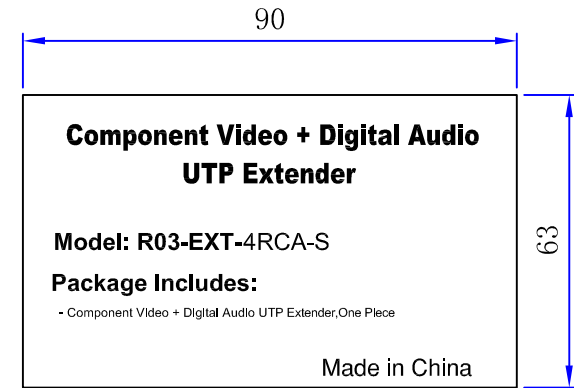

LABEL-3 90\*63MM

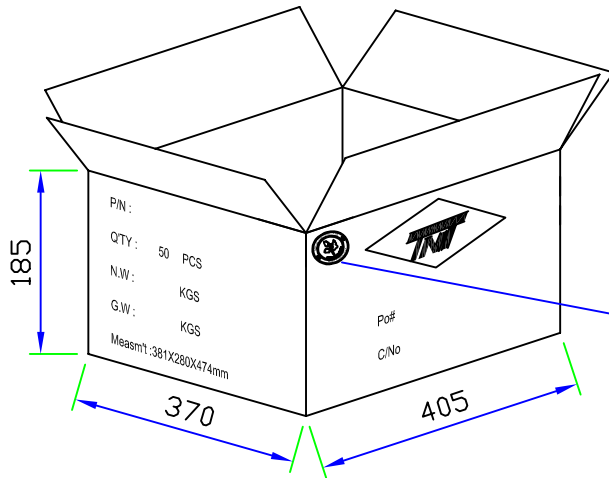

Outer Carton

The round RoHS label(1pcs)

A	INITIAL RELEASE		02/25/10	
REV	DESCRIPTION OF CHANGE		DATE	
TOLERANCE INCHES		M/M	TNT Tri-Net Technology, Inc. http://www.trinetusa.com	
.X	.015	.30	SCALE	NONE
.XX	.010	.10	UNIT	MM
.XXX	.005	.05	SHEET	3/3
DRAWN BY: starl		DATE: 02/25/10	DWG NO.	
CHECK BY:		TITLE: COMPONENT VIDEO+DIGITAL AUDIO(4RCA)		
APPD BY:		PART NO.: R03-EXT-4RCA		

