

CUSTOMER: TNTUSA

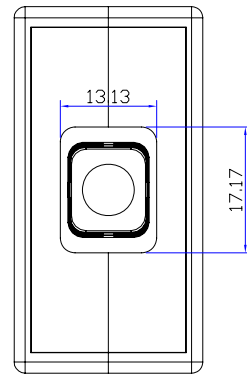

The back of product

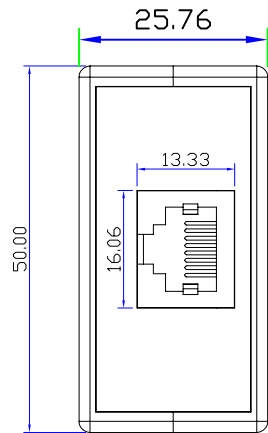
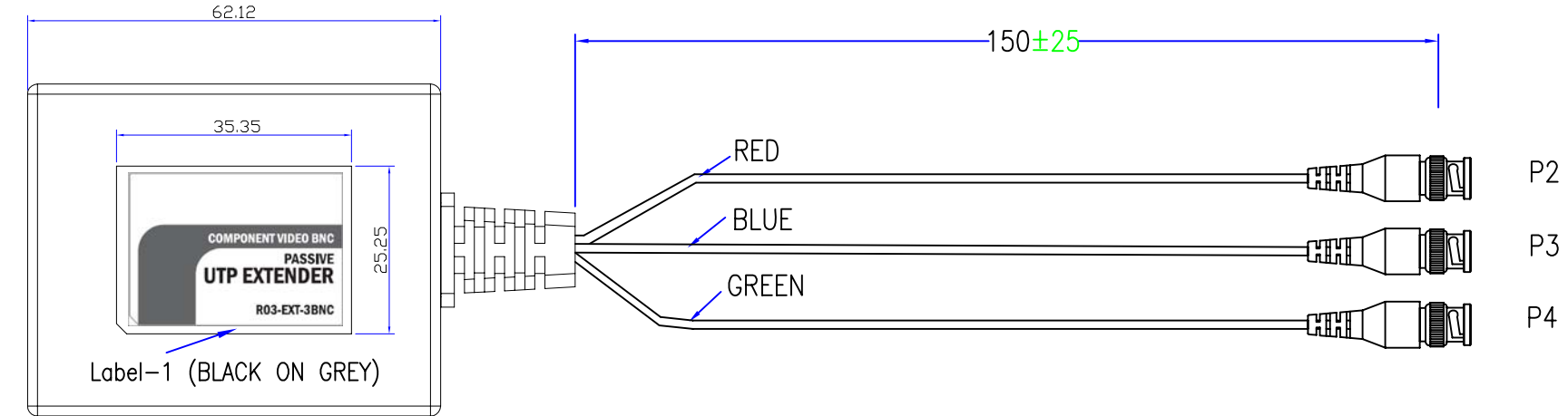
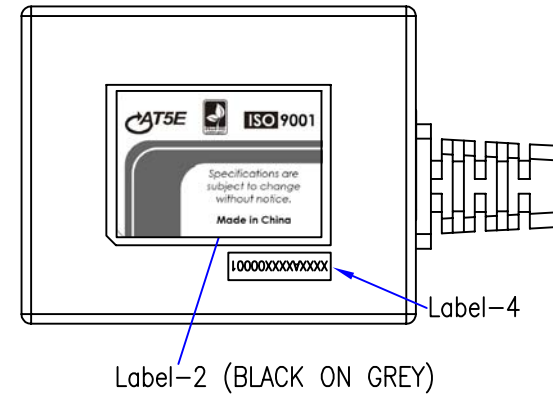

**Description:**

The perfect solution for connecting component video devices using UTP(Cat5/5e/6) cable, this Component Video (YPbPr) UTP Extender lets you extend signals up to 300ft./100m. R03-EXT-3BNC is comprised of two extender units that can be used interchangeably: one is installed near the video signal source, the other to be placed near the desired display, up to an impressive 300ft./100m away. With no software or power adapter required, installation and setup is quick and hassle-free.

|           |                       |     |               |   |
|-----------|-----------------------|-----|---------------|---|
| A         | INITIAL RELEASE       |     | 02/22/11      |   |
| REV       | DESCRIPTION OF CHANGE |     | DATE          |   |
| TOLERANCE |                       | M/M |               | Tri-Net Technology, Inc.<br><a href="http://www.trinetusa.com">http://www.trinetusa.com</a> |
| INCHES    |                       |     |               |   |
| .X        | .015                  | .30 |               |   |
| .XX       | .010                  | .10 | SCALE NONE    | REV A   |
| .XXX      | .005                  | .05 | UNIT MM       |   |
| DRAWN BY  | jon                   |     | SHEET 1/4     | DWG NO.   |
| CHECK BY  |                       |     | DATE 02/22/11 | TITLE   |
| APPD BY   |                       |     | PART NO.      | COMPONENT VIDEO(3BNC)   |
|           |                       |     | R03-EXT-3BNC  |   |



CUSTOMER: TNTUSA

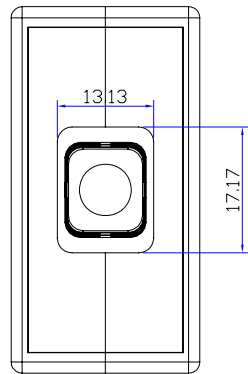
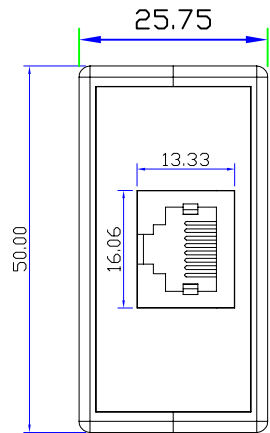
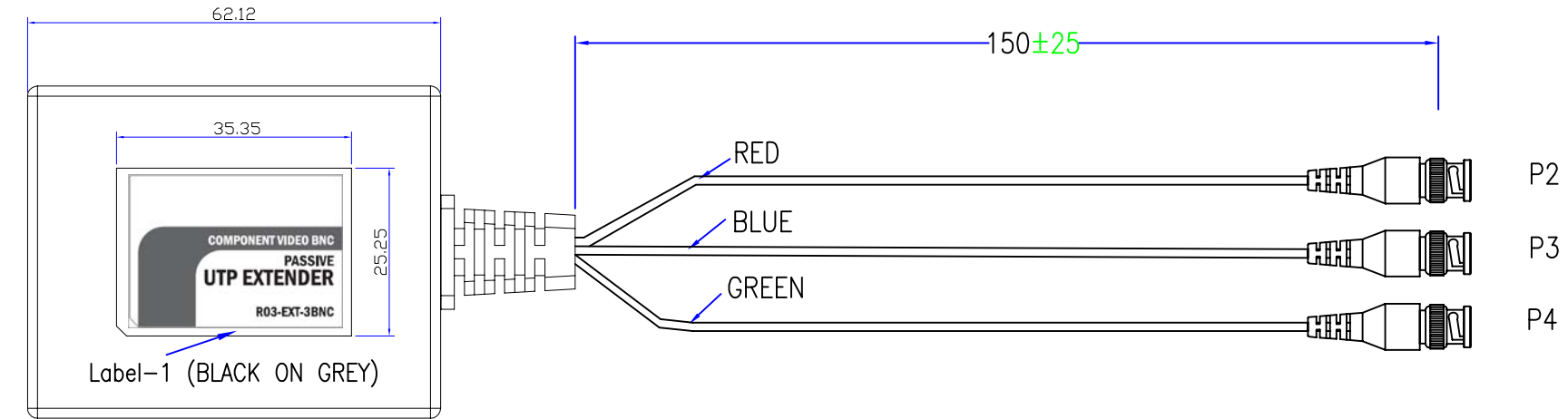

The back of product

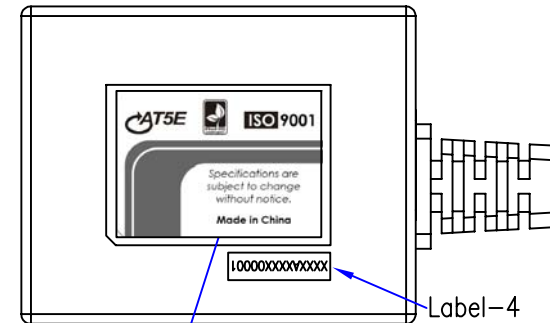

Features:

- No software or power adapter required for easy installation.
- Support up HDTV (.480p/720p/1080i)
- Works with UTP (Cat5/5e/6) cable.
- Shell color: Black

Applications

- To be used in home or commercial applications as a fast, and cost-effective means of connecting composite video equipment.
- Ideal for classrooms, projectors, convention facilities, and retail displays.

|           |                       |   |          |          |
|-----------|-----------------------|---|----------|----------|
| A         | INITIAL RELEASE       |   | 02/22/11 |          |
| REV       | DESCRIPTION OF CHANGE |   | DATE     |          |
| TOLERANCE |                       | Tri-Net Technology, Inc.<br><a href="http://www.trinetusa.com">http://www.trinetusa.com</a> |          |          |
| .X        | .015                  | .30   | SCALE    | NONE     |
| .XX       | .010                  | .10   | UNIT     | MM       |
| .XXX      | .005                  | .05   | SHEET    | 2/4      |
| DRAWN BY  |                       | jon   | DATE     | 02/22/11 |
| CHECK BY  |                       | TITLE   |          |          |
| APPD BY   |                       | PART NO.  |          |          |
|           |                       | R03-EXT-3BNC  |          |          |



CUSTOMER: TNTUSA

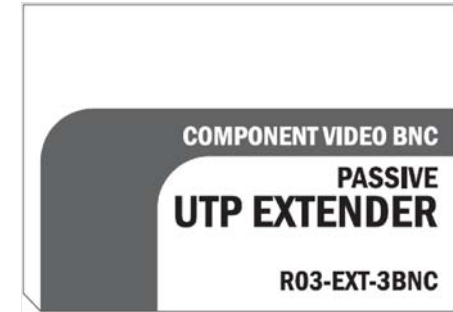
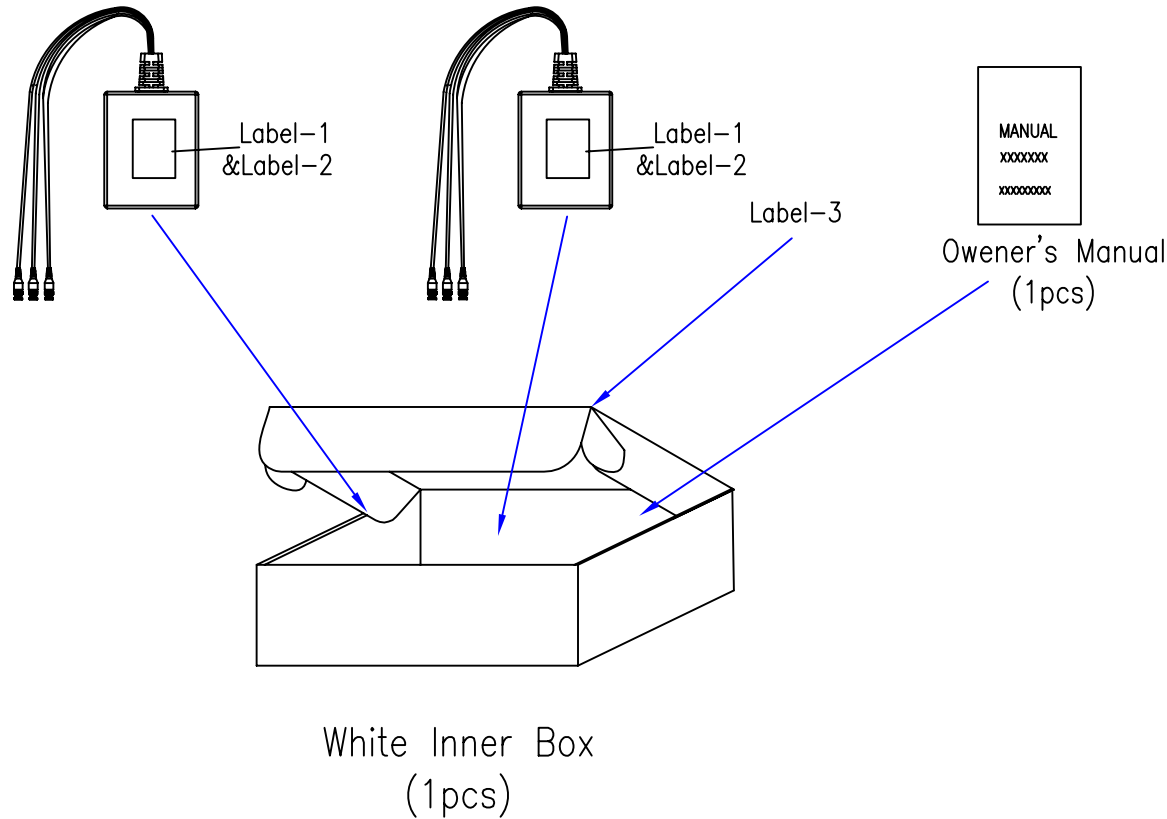

Packaging Details:

- 1) Stick the label-1 onto the Product's TOP.  
Label-2, Label-4 onto the Product's Bottom.
- 2) Need to put owner's manual and power adapter inside the inner box
- 3) Stick the Label-3 onto this inner box.
- 4) Finally, pack the whole item using pyrocondensation film.
- 5) Inner box size: 134(L)X123(W)X41(H)MM
- 6) Outer carton size: 381(L)X280(W)X474(H)MM
- 7) Put 50pcs of inner boxes into an outer carton. Need to put 4pcs of Overpack Labels onto the main/side marks portion of the outer carton.

Label-2(34.5\*25mm)  
(BLACK ON GREY)

|           |                       |  |                       |          |
|-----------|-----------------------|--|-----------------------|----------|
| A         | INITIAL RELEASE       |  | 02/22/11              |          |
| REV       | DESCRIPTION OF CHANGE |  | DATE                  |          |
| TOLERANCE |                       | TNT Tri-Net Technology, Inc.<br>http://www.trinetusa.com |                       |          |
| INCHES    |                       | SCALE NONE   |                       |          |
| .X        | .015                  | .30  | UNIT                  | MM       |
| .XX       | .010                  | .10  | SHEET                 | 3/4      |
| .XXX      | .005                  | .05  | DATE                  | 02/22/11 |
| DRAWN BY  | jon                   |  | DWG NO.               |          |
| CHECK BY  | TITLE                 |  | COMPONENT VIDEO(3BNC) |          |
| APPD BY   | PART NO.              |  | R03-EXT-3BNC          |          |



CUSTOMER: TNTUSA

Version Label

XXXXAXXX00001

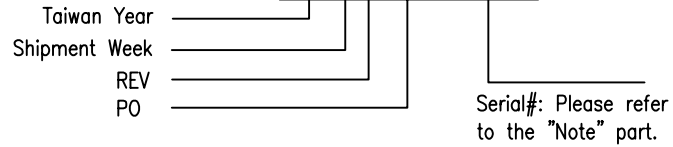

Label-2  
(18x6, Black on White)

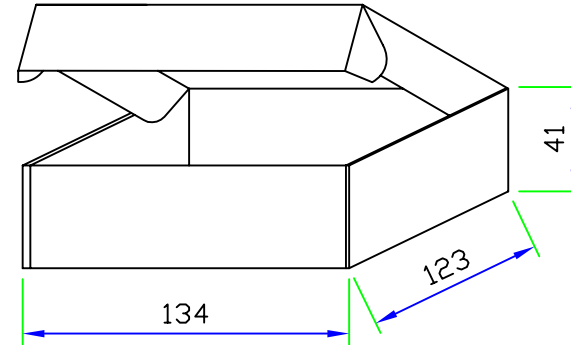

White Inner Box

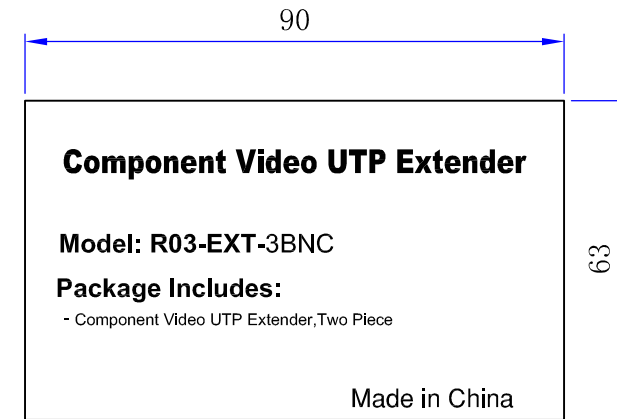

标签-3  
标签尺寸: 90x63mm  
标签颜色: 黑白

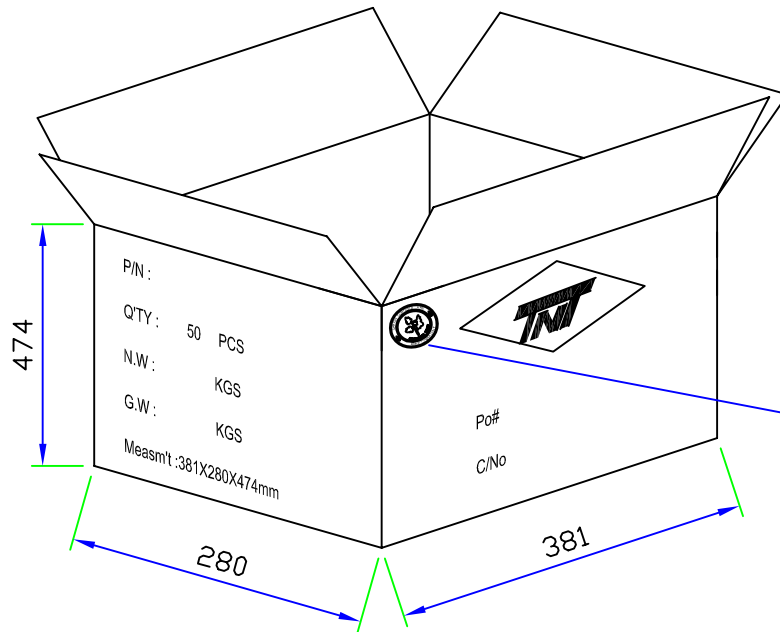

Outer Carton

|           |                       |                          |                          |          |
|-----------|-----------------------|--------------------------|--------------------------|----------|
| A         | INITIAL RELEASE       |                          | 02/22/11                 |          |
| REV       | DESCRIPTION OF CHANGE |                          | DATE                     |          |
| TOLERANCE |                       | Tri-Net Technology, Inc. |                          |          |
| INCHES    |                       | M/M                      |                          |          |
| .X        | .015                  | .30                      | http://www.trinetusa.com |          |
| .XX       | .010                  | .10                      | SCALE                    | NONE     |
| .XXX      | .005                  | .05                      | UNIT                     | MM       |
| DRAWN BY  |                       | jon                      | SHEET                    | 4/4      |
| CHECK BY  |                       |                          | DATE                     | 02/22/11 |
| APPD BY   |                       |                          | DWG NO.                  |          |
|           |                       | TITLE                    |                          |          |
|           |                       | COMPONENT VIDEO(3BNC)    |                          |          |
|           |                       | PART NO.                 |                          |          |
|           |                       | R03-EXT-3BNC             |                          |          |

