

CUSTOMER: TNTUSA

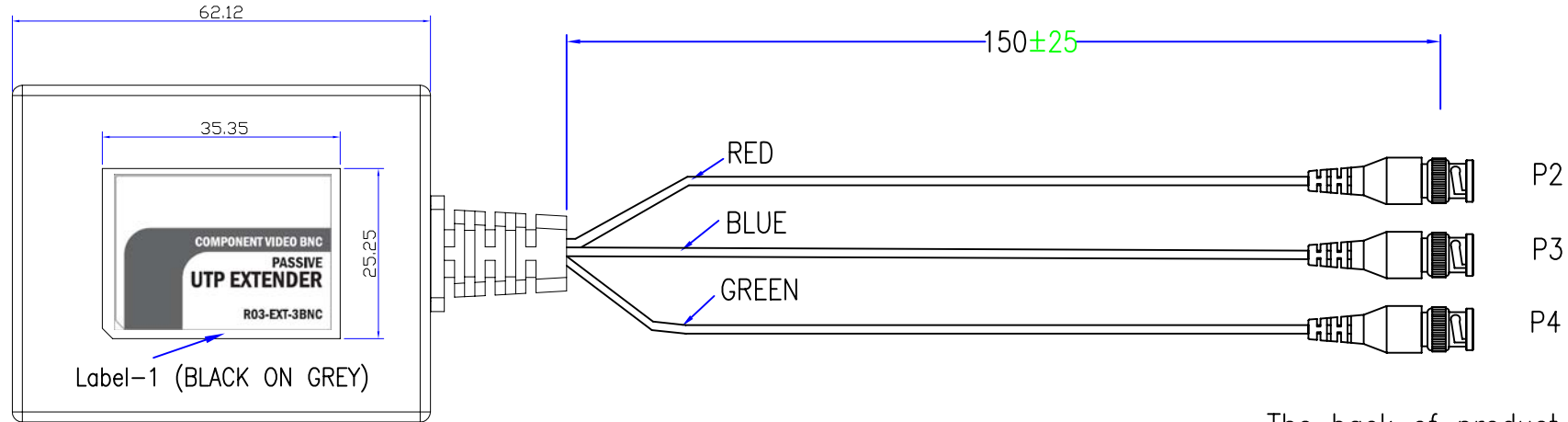

The back of product

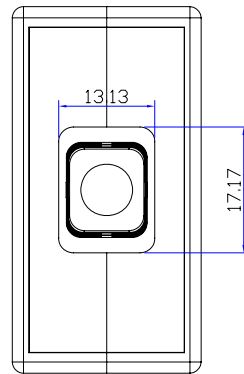
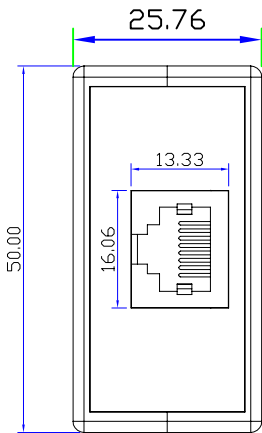

Features:

- No software or power adapter required for easy installation.
- Support up HDTV (.480p/720p/1080P)
- Works with UTP (Cat5/5e/6) cable.
- Shell color: Black

Applications

- To be used in home or commercial applications as a fast, and cost-effective means of connecting composite video equipment.
- Ideal for classrooms, projectors, convention facilities, and retail displays.

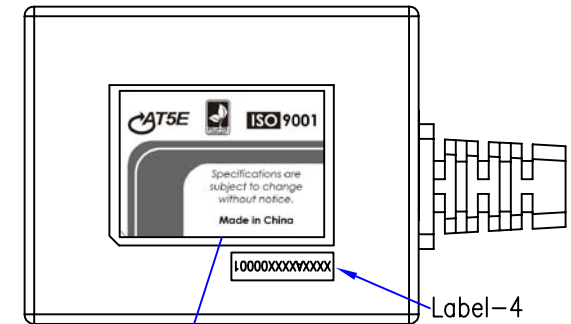

Label-2 (BLACK ON GREY)

Description:

The perfect solution for connecting component video devices using UTP(Cat5/5e/6) cable, this Component Video (YPbPr) UTP Extender lets you extend signals up to 300ft./100m. With no software or power adapter required, installation and setup is quick and hassle-free.

A	INITIAL RELEASE		02/22/11	
REV	DESCRIPTION OF CHANGE		DATE	
TOLERANCE			Tri-Net Technology, Inc. <a href="http://www.trinetusa.com">http://www.trinetusa.com</a>	
INCHES				
M/M				
.X	.015	.30	SCALE	NONE
.XX	.010	.10	UNIT	MM
.XXX	.005	.05	SHEET	1/3
DRAWN BY		jon	DATE	02/22/11
CHECK BY			TITLE	
APPD BY			PART NO.	
			COMPONENT VIDEO(3BNC),ONE PIECE	
			R03-EXT-3BNC-S	



CUSTOMER: TNTUSA

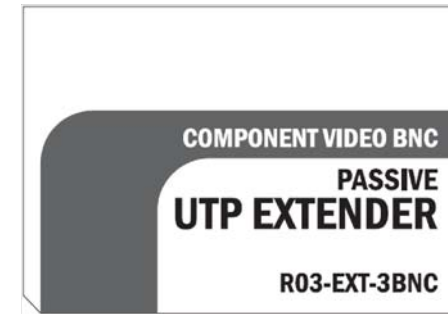
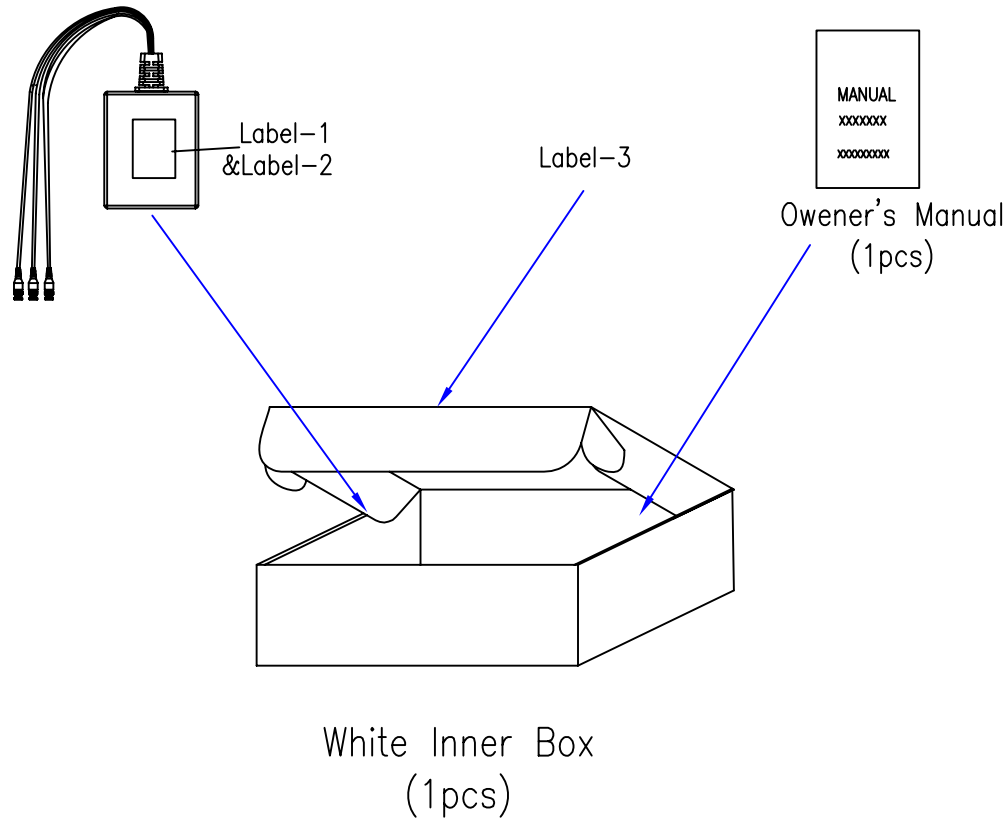

Label-1(34.5\*25mm)  
(BLACK ON GREY)



Label-2(34.5\*25mm)  
(BLACK ON GREY)

Packaging Details:

- 1) Stick the label-1 onto the Product's TOP.  
Label-2, Label-4 onto the Product's Bottom.
- 2) Need to put owner's manual inside the inner box
- 3) Stick the Label-3 onto this inner box.
- 4) Finally, pack the whole item using pyrocondensation film.
- 5) Inner box size: 125(L)X75(W)X29(H)MM
- 6) Outer carton size: 405(L)X370(W)X185(H)MM
- 7) Put 50pcs of inner boxes into an outer carton. Need to put 4pcs of Overpack Labels onto the main/side marks portion of the outer carton.

A	INITIAL RELEASE		02/22/11	
REV	DESCRIPTION OF CHANGE		DATE	
TOLERANCE		TNT Tri-Net Technology, Inc. http://www.trinetusa.com		
INCHES		SCALE NONE		
.X	.015	.30	REV A	
.XX	.010	.10	DWG NO.	
.XXX	.005	.05	SHEET 3/4	
DRAWN BY jon		DATE 02/22/11		
CHECK BY		TITLE COMPONENT VIDEO(3BNC)		
APPD BY		PART NO. R03-EXT-3BNC		



CUSTOMER: TNTUSA

Version Label

XXXXAXXXX00001

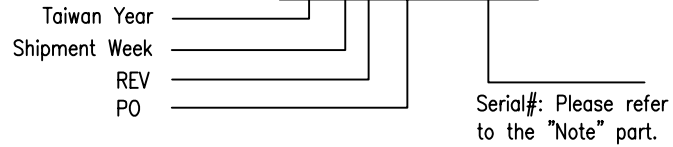

Label-2  
(18x6, Black on White)

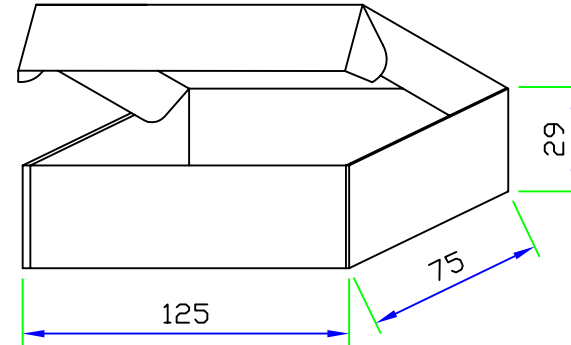

White Inner Box

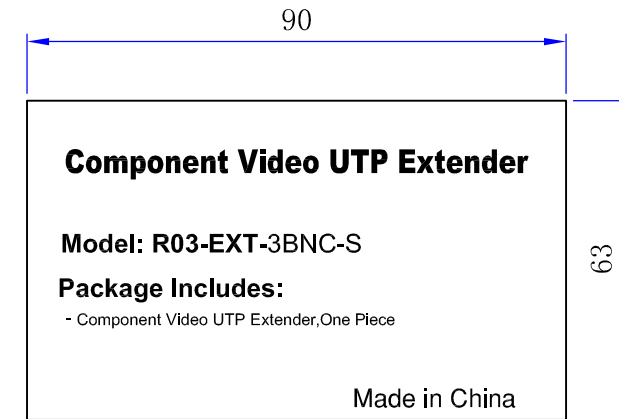

标签-3  
标签尺寸: 90x63mm  
标签颜色: 黑白

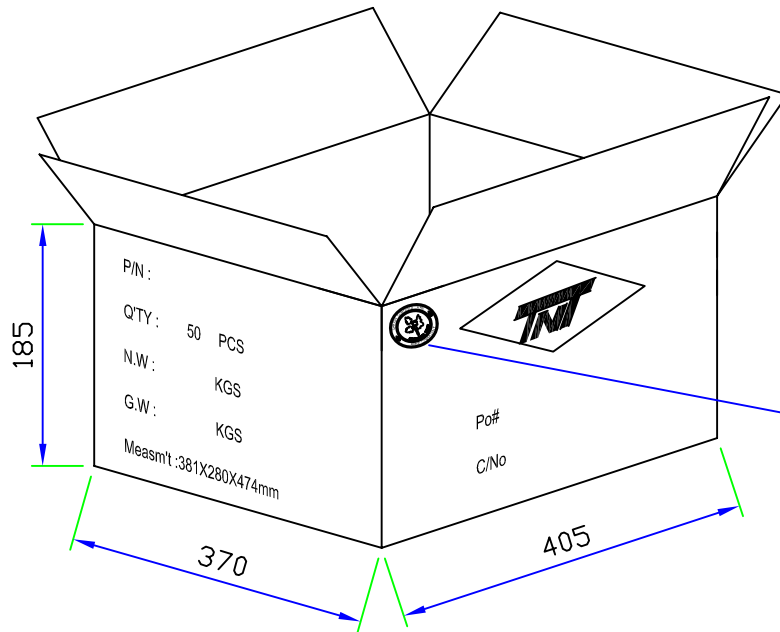

Outer Carton

A	INITIAL RELEASE		02/22/11	
REV	DESCRIPTION OF CHANGE		DATE	
TOLERANCE		M/M		Tri-Net Technology, Inc. <a href="http://www.trinetusa.com">http://www.trinetusa.com</a>
INCHES				
.X	.015	.30		
.XX	.010	.10		
.XXX	.005	.05		SCALE NONE UNIT MM SHEET 4/4 DATE 02/22/11 DWG NO.
DRAWN BY	jon		REV A	
CHECK BY	TITLE		COMPONENT VIDEO(3BNC)	
APPD BY	PART NO.		R03-EXT-3BNC	

