

HEX. NUT:  
#4-40UNC (X10)



DRAWING APPROVED \_\_\_\_\_ DATE: \_\_\_\_\_

SAMPLE APPROVED PER DRAWING SPECIFICATIONS \_\_\_\_\_ DATE: \_\_\_\_\_

PROPRIETARY & CONFIDENTIAL. THIS DOCUMENT MAY NOT BE COPIED, OR DISCLOSED IN WHOLE OR IN PART WITHOUT THE WRITTEN CONSENT OF TNT.

<input type="checkbox"/> O  <input type="checkbox"/> S	DIMENSIONAL TOLERANCES UNLESS OTHERWISE NOTED .X ±      .XX ± .XXX ±    ANGLES ± REV. ∅    CUS. REV.	TITLE <b>MANUAL DATA SWITCH</b> CUS. NAME CUS. P/N <b>A02-PV-515-4</b> PART NO. <b>P9910015-E</b>	 ENG. _____ DATE _____ CHECKED _____ DATE _____ APPROVED _____ DATE _____
--	---	---	---

PIN OUT

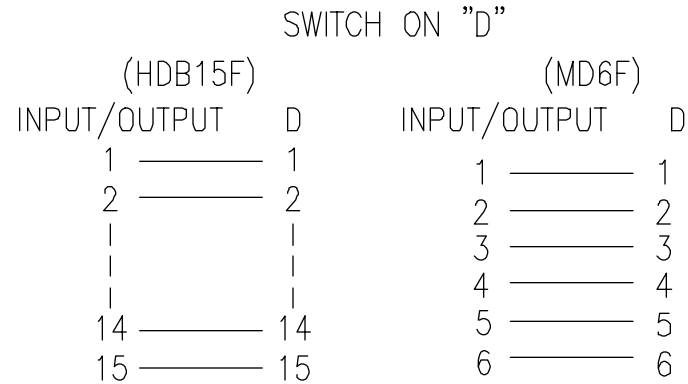
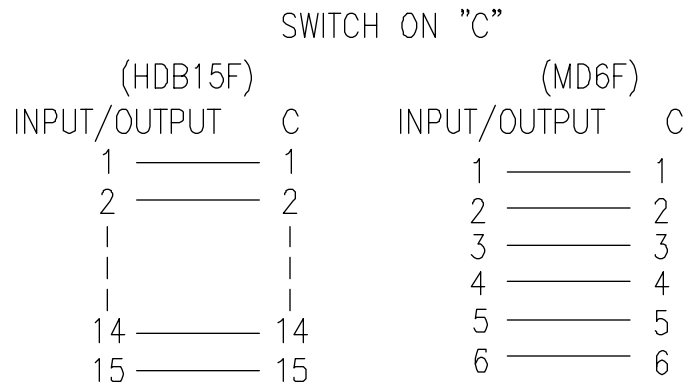
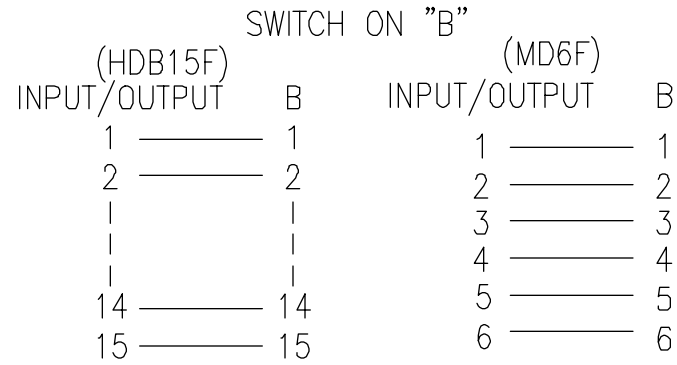
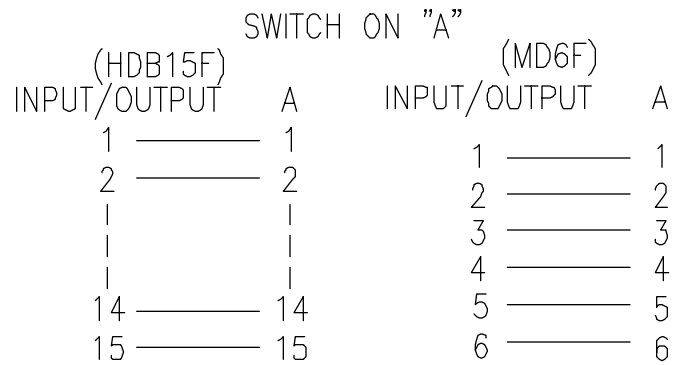

NOTE:

1. PACKING: EACH MANUAL DATA SWITCH IN A BOX, BAR CODE LABEL (WHITE BACKGROUND WITH BLACK LETTERS, CODE: 39) TO BE STAMPED ON BOX TO READ:

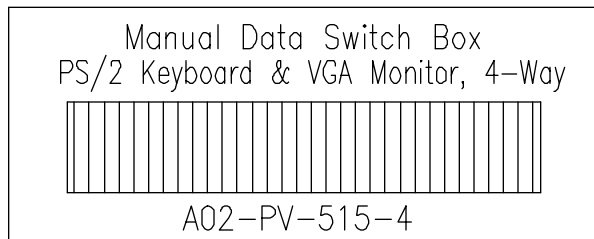

DRAWING APPROVED _____		DATE: _____	
SAMPLE APPROVED PER DRAWING SPECIFICATIONS _____		DATE: _____	
PROPRIETARY & CONFIDENTIAL. THIS DOCUMENT MAY NOT BE COPIED, OR DISCLOSED IN WHOLE OR IN PART WITHOUT THE WRITTEN CONSENT OF TNT.			
	mm	TITLE <b>MANUAL DATA SWITCH PIN OUT</b>	
SCALE	NONE		
SHEET	2/2		
DIMENSIONAL TOLERANCES UNLESS OTHERWISE NOTED		CUS. NAME	
<input type="checkbox"/> 0	.X ±      .XX ±	CUS. P/N	
<input type="checkbox"/> S	.XXX ±    ANGLES ±	A02-PV-515-4	
REV. ∅	CUS. REV.	PART NO. P9910015-E	
		ENG.	DATE
		CHECKED	DATE
		APPROVED	DATE