

REVISIONS				
ZONE	REV	DESCRIPTION	DATE	APPROVED

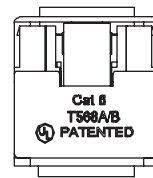

Cat 6  
UL CERTIFIED  US LISTED

ACCORDING TO EIA/TIA-568-B.2-1.  
REQUIREMENTS  
FILE NO.E145249

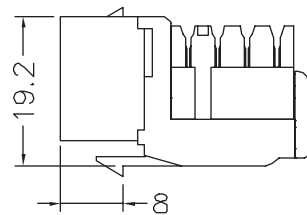
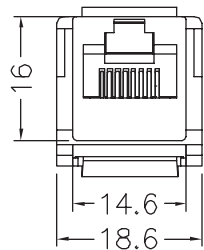
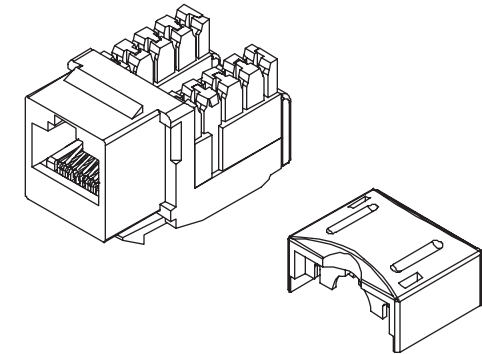
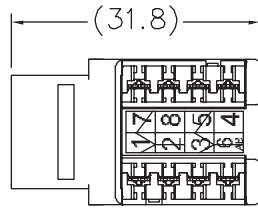
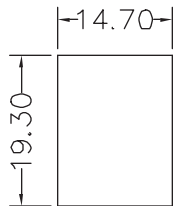

SUGGESTED PANEL  
CUTOUT

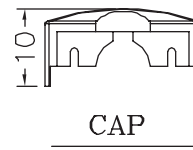
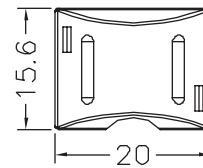
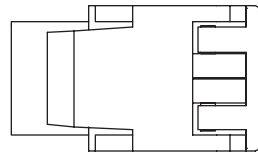

CAP

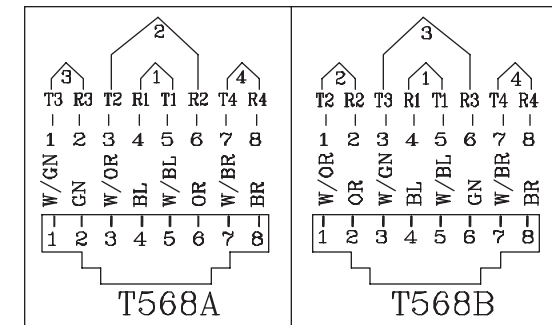

PHYSICAL SPECIFICATIONS:  
PLASTIC: UL 94V-0 THERMOPLASTIC  
JACK WIRE: 50u" GOLD PLATING OVER 100u" NICKEL UNDER PLATE

COMMON TOLERANCE		SHEET 1 OF 1		ALL COPY RIGHTS RESERVED	
DIMENSION	CLASS	A	B	SIZE A4	 Tri-Net Technology/USA
	L <= 3	±0.05	±0.1	UNIT: mm	
	3 < L <= 6	±0.05	±0.1	DATE: 06/10/02	PART MUNBER 07WF-188-XX
	6 < L <= 16	±0.1	±0.15	DWG NO, A0301	
	16 < L <= 30	±0.1	±0.2	SCALE: NONE	DRAWN BY EVA   CHECKED BY DANNY
	30 < L <= 120	±0.15	±0.3		
	120 < L <= 315	±0.2	±0.5		