

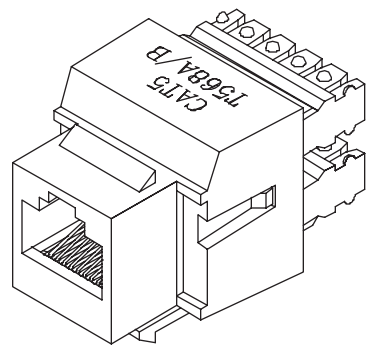

| REVISIONS | | | | |
|-----------|-----|-------------|------|----------|
| ZONE | REV | DESCRIPTION | DATE | APPROVED |



CAT.5
UL CERTIFIED

 ACCORDING TO TSB-40A
 REQUIREMENTS
 FILE NO.E145249

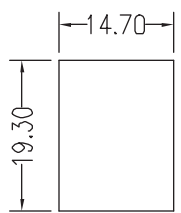
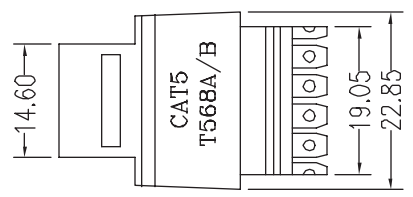
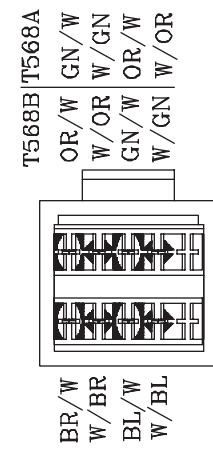
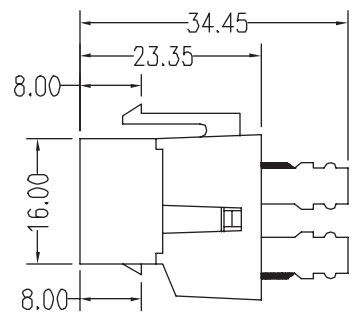
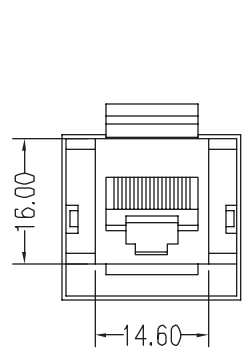

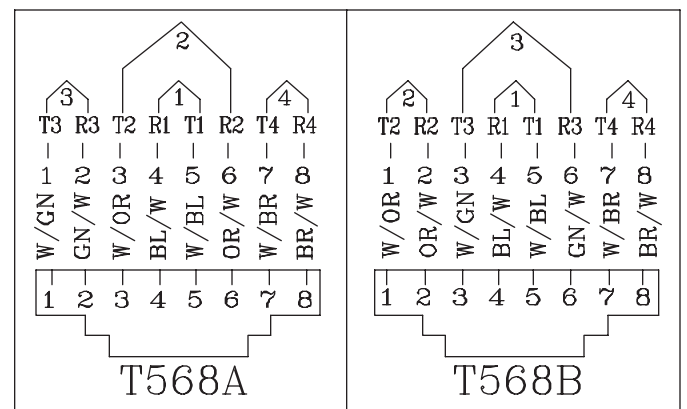
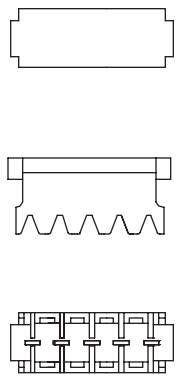
SUGGESTED PANEL
CUTOUT



PHYSICAL SPECIFICATIONS:

PLASTIC: UL 94V-0 THERMOPLASTIC
 JACK WIRE: 50u" GOLD PLATING OVER 100u" NICKEL UNDER PLATE

| COMMON TOLERANCE | | | SHEET OF | | ALL COPY RIGHTS RESERVED | |
|------------------|-----------|-------|----------|----------------|--------------------------|-----------------------------------|
| DIMENSION | CLASS | A | B | SIZE | A4 | TNT Tri-Net Technology/USA |
| | L<=3 | ±0.05 | ±0.1 | DIA | mm | |
| | 3<L<=6 | ±0.05 | ±0.1 | | | 070-188-XX |
| | 6<L<=16 | ±0.1 | ±0.15 | SCALE | DRAWING NO. | |
| | 16<L<=30 | ±0.1 | ±0.2 | DATE NOV.05.98 | K-025 | |
| | 30<L<=120 | ±0.15 | ±0.3 | DESIGN | DRAWN | CHECKED |
| 120<L<=315 | ±0.2 | ±0.5 | | | | |